

ÚPRAVY RAZNÍKŮ-MATRIC / / MODIFICATION PUNCHES-DIES

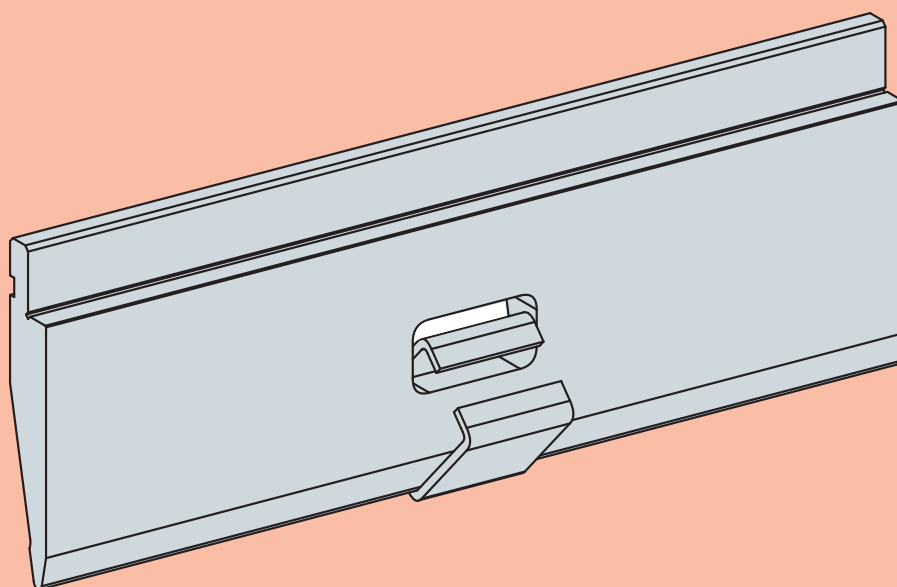
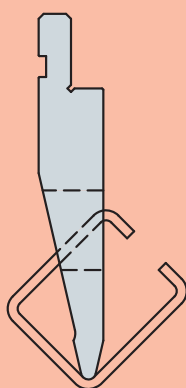
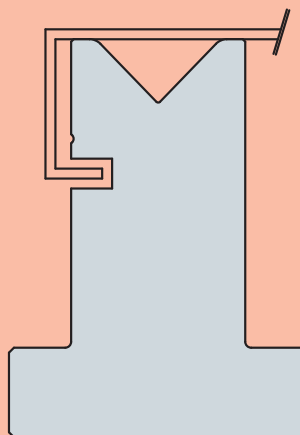
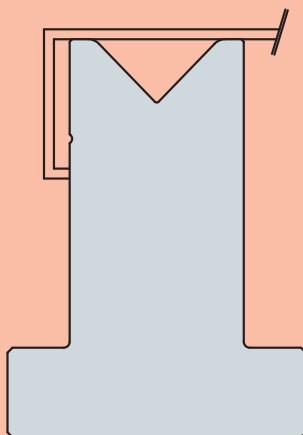
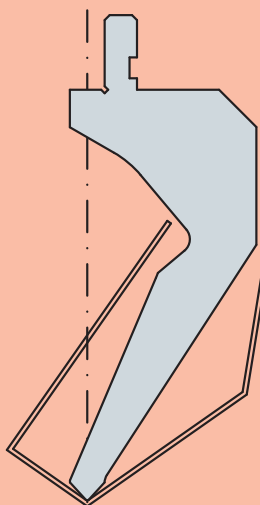
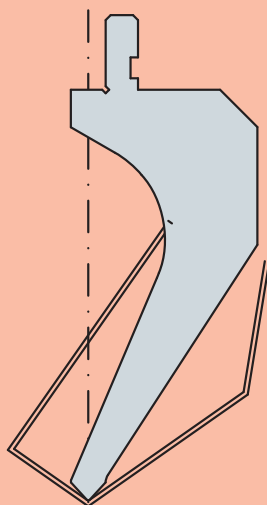
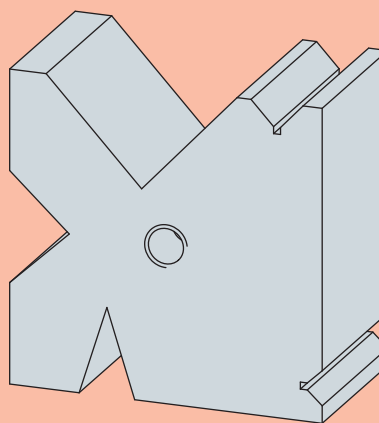
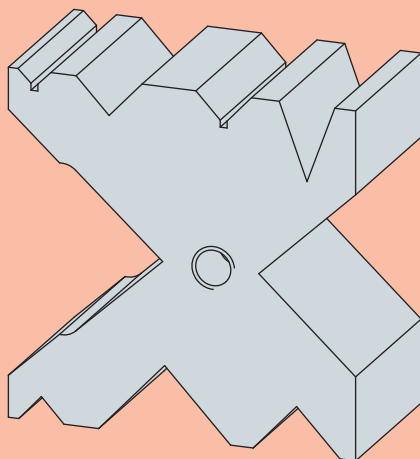
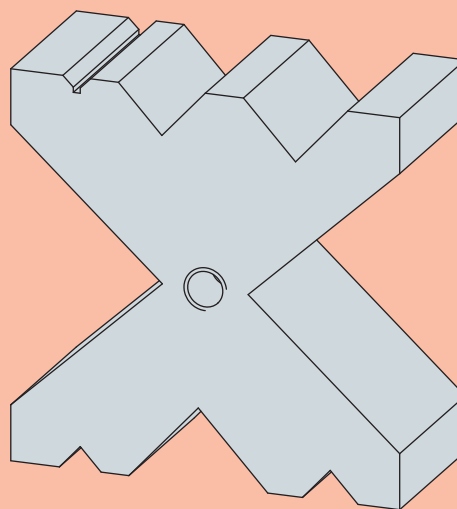
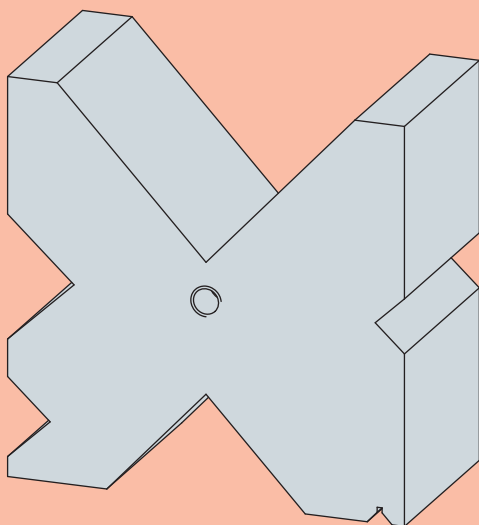
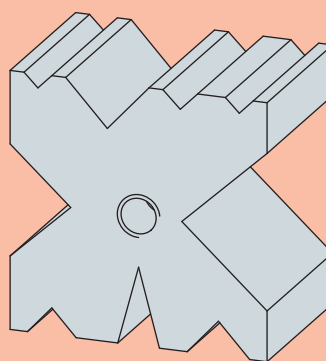
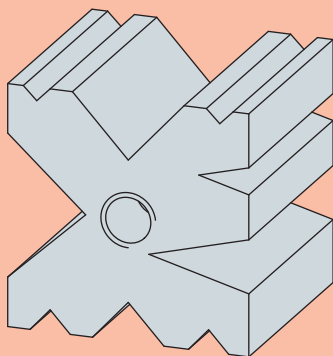

## MULTI V MATRICE / MULTI MATRICE - VS ON REQUEST

**Materiali / Material:**

1.2312  
C45  
42CrM04

**Lavorazioni / Working:**

Kalená / Hardened  
Zušlechtená nitridovaná /  
Quenched-nitrided  
Hoblované / Planed  
Upravené / Grounded

**Lunghezze / Length (mm):**

2000  
3000  
4000  
6000  
8000

SPECIÁLNÍ NÁSTROJE DLE PŘÁNÍ ZÁKAZNÍKA LVD

SPECIAL TOOLS ON REQUEST LVD

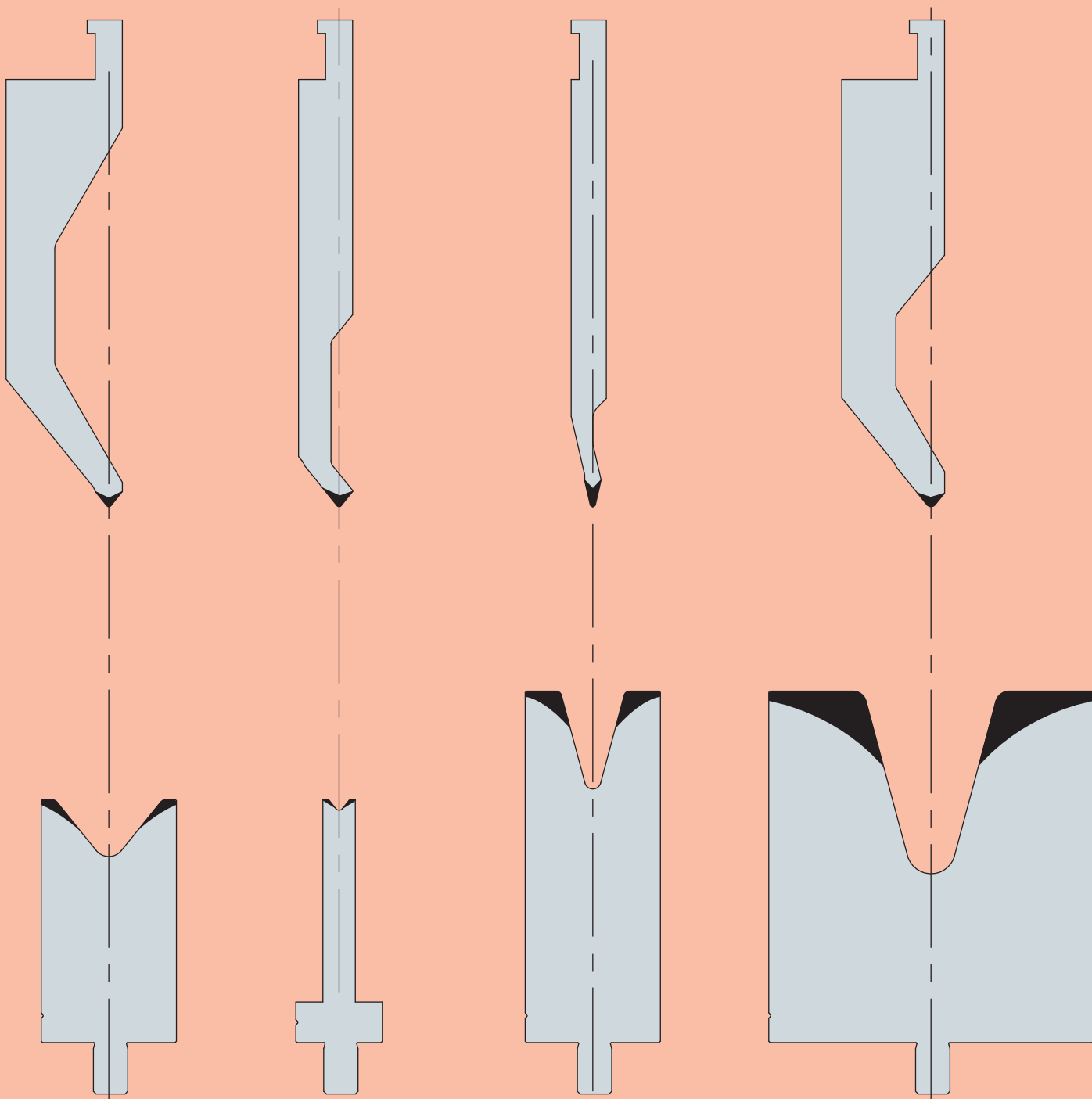

SPECIÁLNÍ NÁSTROJE DLE PŘÁNÍ ZÁKAZNÍKA LVD A WILA

SPECIAL TOOLS ON REQUEST **LVD ATT. WILA**

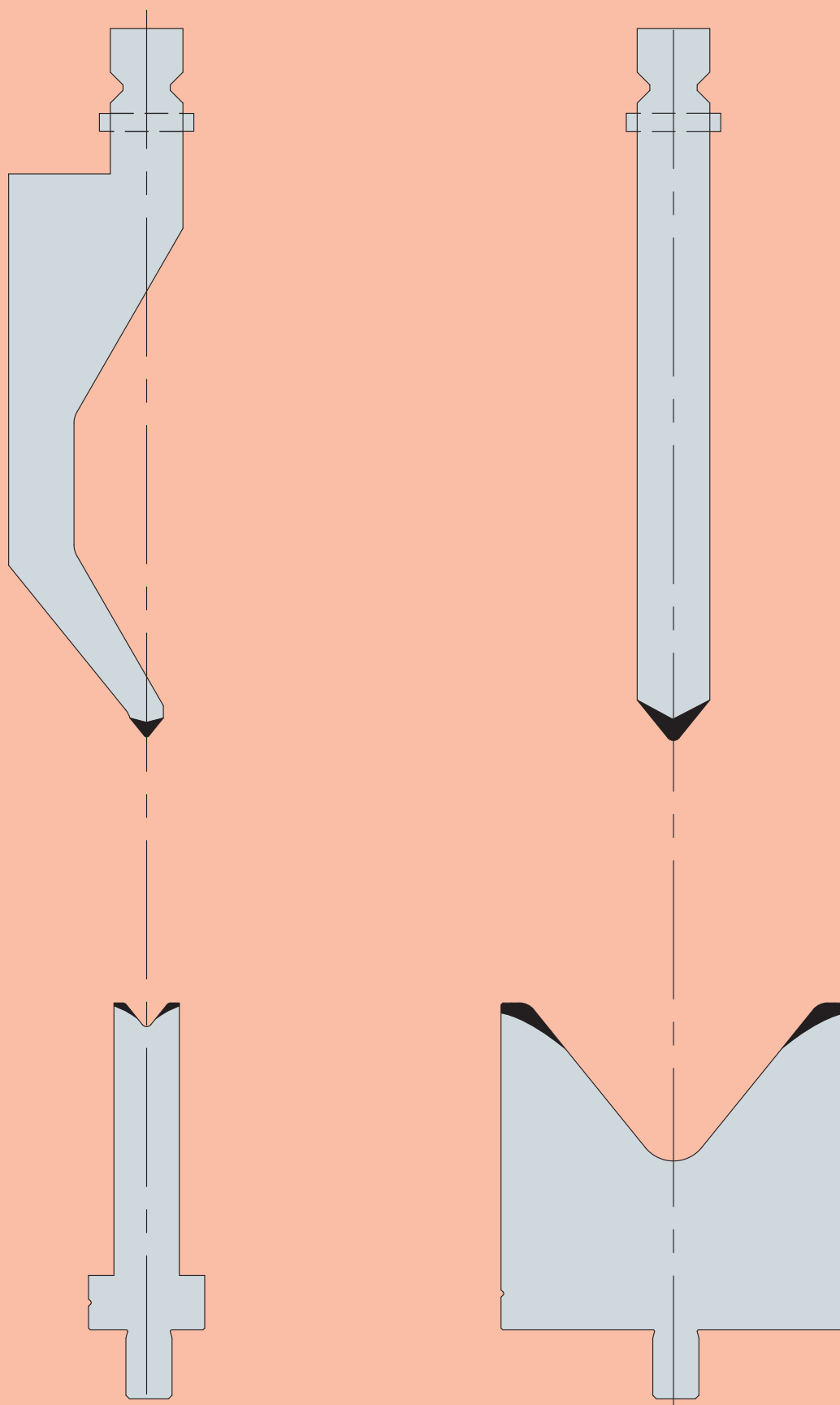

SPECIÁLNÍ NÁSTROJE DLE PŘÁNÍ ZÁKAZNÍKA WEINBRENNER

SPECIAL TOOLS ON REQUEST WEINBRENNER

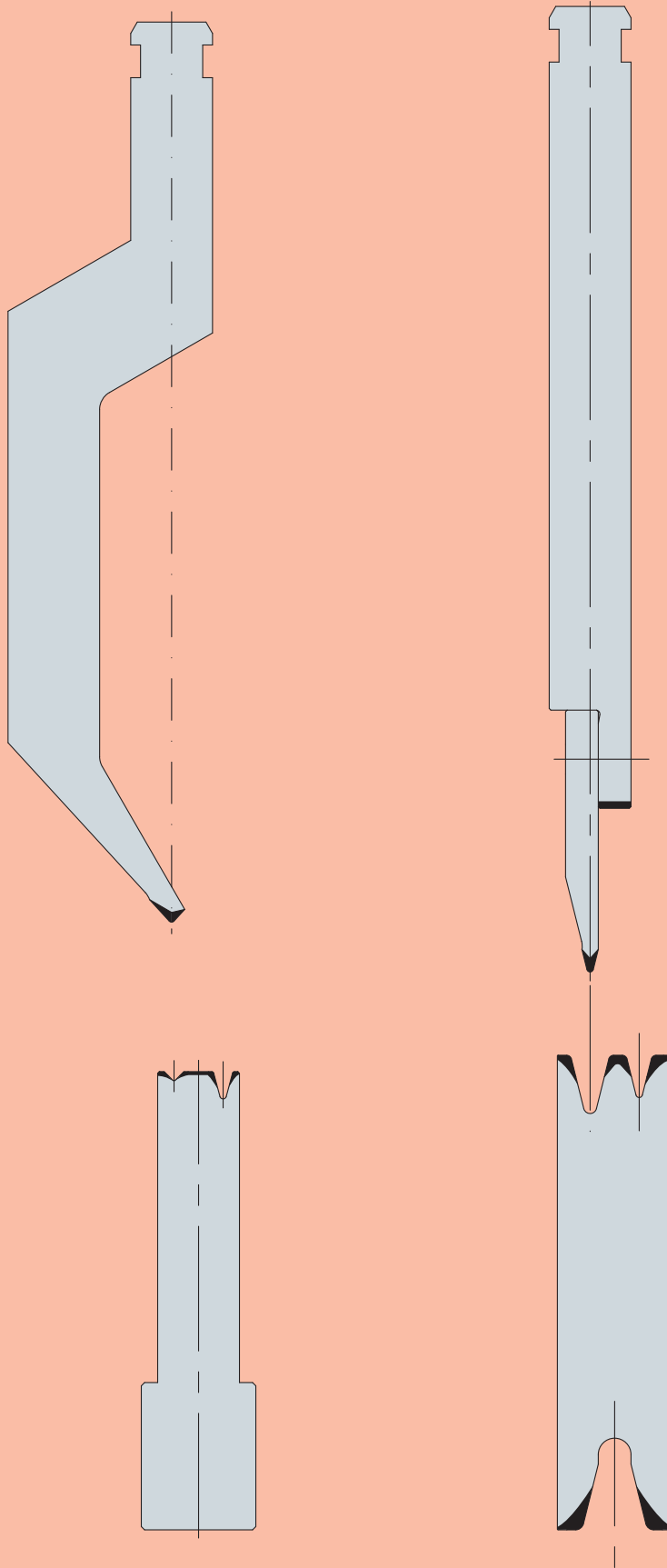

SPECIÁLNÍ NÁSTROJE DLE PŘÁNÍ ZÁKAZNÍKA EHT

SPECIAL TOOLS ON REQUEST **EHT**

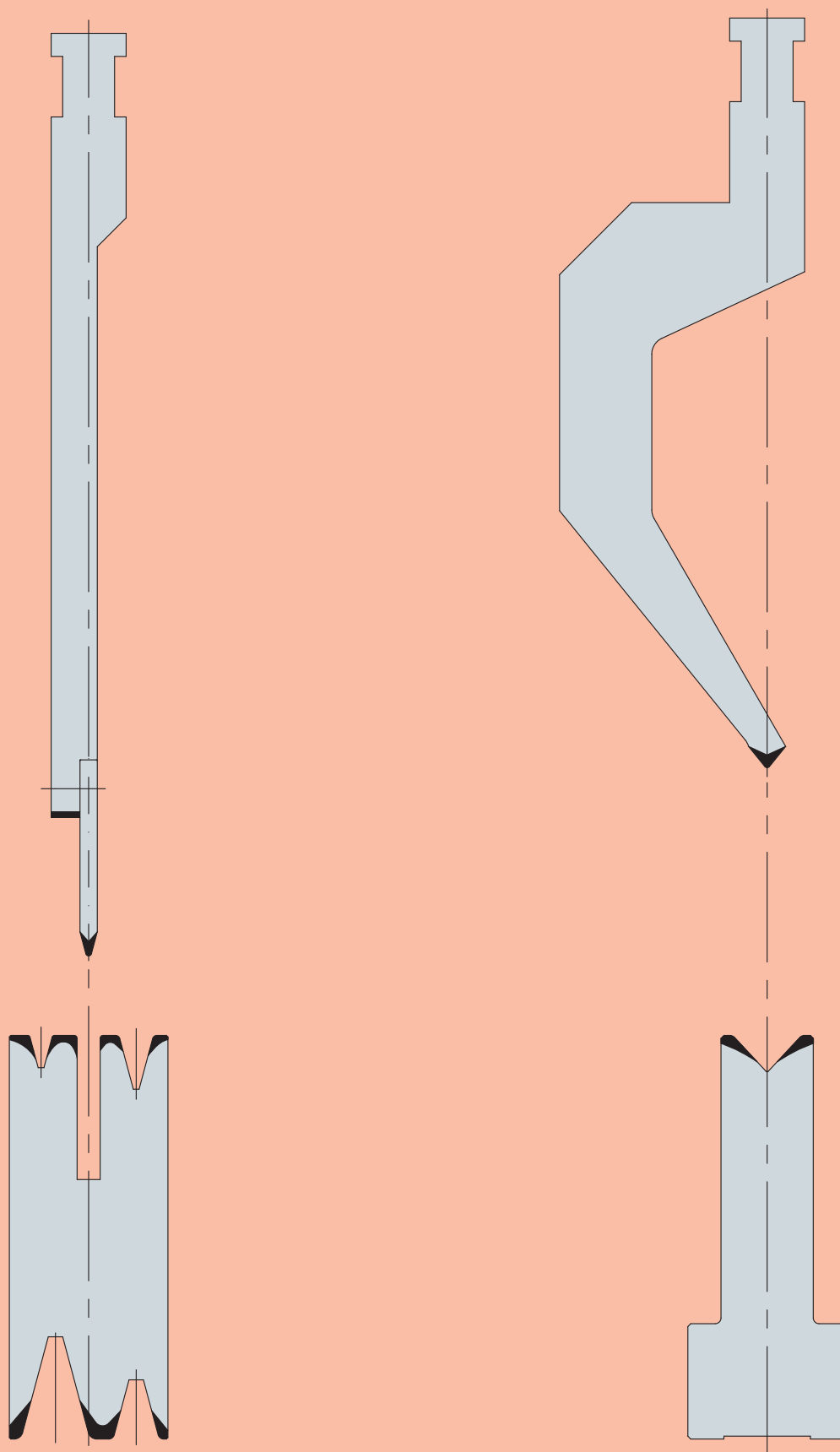

SPECIÁLNÍ NÁSTROJE DLE PŘÁNÍ ZÁKAZNÍKA

SPECIAL TOOLS ON REQUEST

- C45 zušlechtěná/quenched
- 42CrMo4
- C45

