

NYLONOVÁ VLOŽKA A DRŽÁKY / NYLON INSERT AND HOLDERS

2109

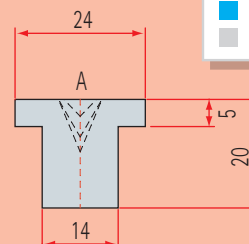
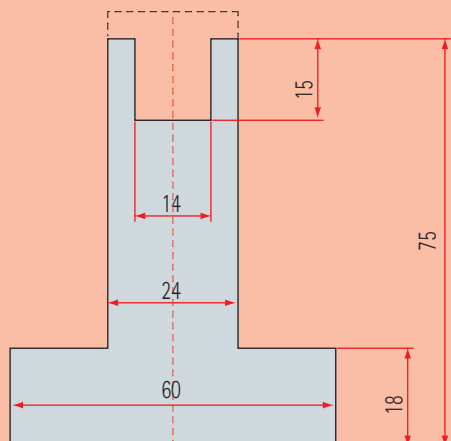

■ C45 zušlechtná/quenched
 ■ 42CrMo4
 ■ C45

2112

A	V		
88°	6	8	10
60°	6	8	10
45°	6	8	10
30°	6	8	

2110

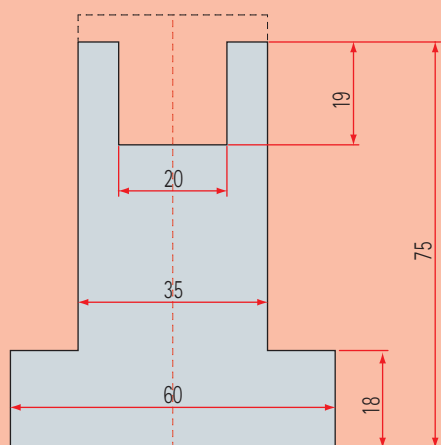

2113

A	V				
88°	6	8	10	12	16
60°	6	8	10	12	16
45°	6	8	10	12	
30°	6	8	10		

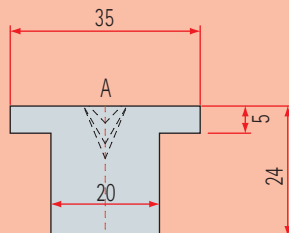

2115	H	50
2116	H	95

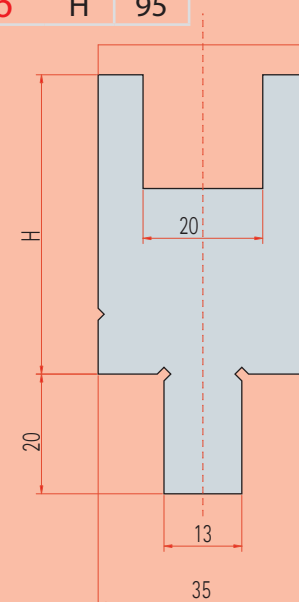

2111

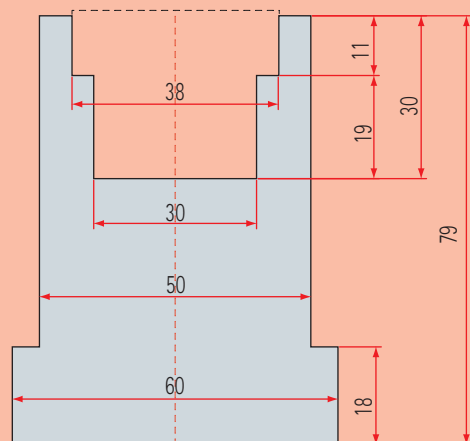

2114

A	V						
88°	6	8	10	12	16	20	25
60°	6	8	10	12	16	20	
45°	6	8	10	12	16	20	
30°	6	8	10	12	16		

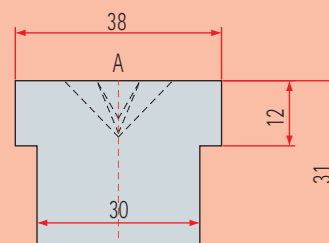

POLYURETANOVÉ VLOŽKY A DRŽÁKY / HOLDERS AND POLYURETHANE INSERTS

- C45 zušlechťená/quenched
- 42CrMo4
- C45

2036

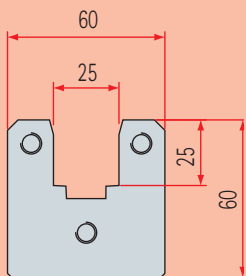

2101

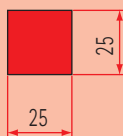

92 shore

2105

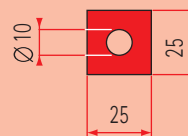

2037

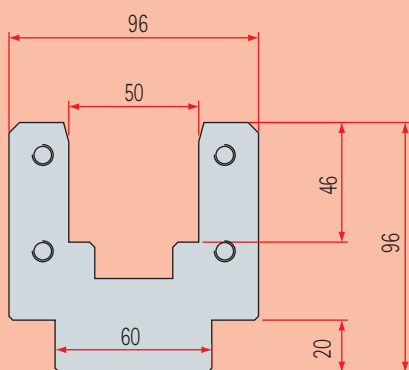

2102

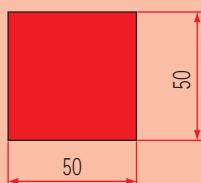

2106

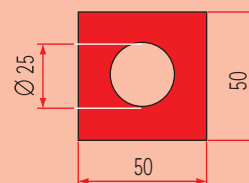

2038

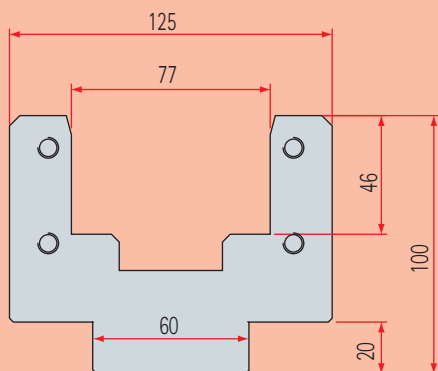

2103

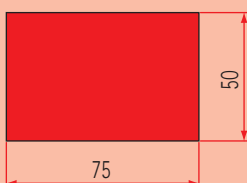

2107

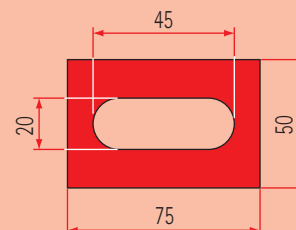

2040

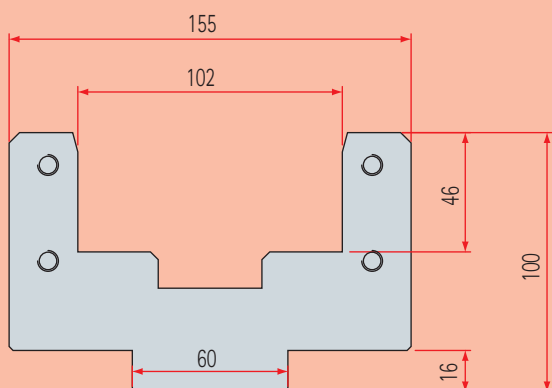

2104



2108

